

INS-M30-B15PO-B3

Induktiver Näherungssensor
 Inductive proximity sensor
 Détecteur de proximité inductif

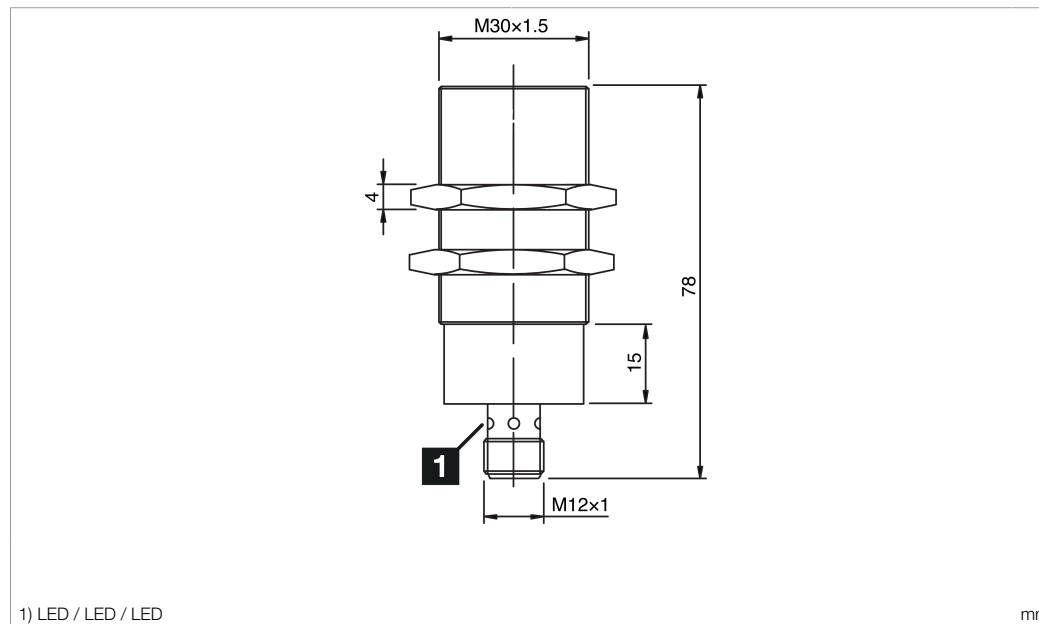

di-soric GmbH & Co. KG
 Steinbeisstraße 6
 DE-73660 Urbach
 Germany
 Tel: +49 (0) 7181/9879-0
 info@di-soric.com · www.di-soric.com



1) LED / LED / LED

mm

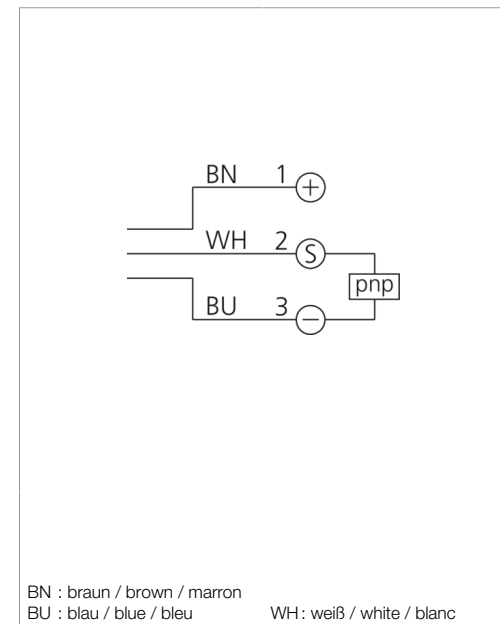

BN : braun / brown / marron
 BU : blau / blue / bleu
 WH: weiß / white / blanc

Stand 16.07.24, Änderungen vorbehalten
 As of 07/16/24, subject to change
 État 16.07.24, sous réserve de modifications



Technische Daten	Technical data	Caractéristiques techniques	+20°C, 24 V DC
Einbauart	Installation type	Type de montage	bündig / Flush / Affleurant
Schaltabstand	Switching distance	Distance de commutation	15 mm
Betriebsspannung	Service voltage	Tension de service	10 ... 30 V DC
Schaltausgang	Switching output	Sortie de commutation	pnp, 200 mA, NC
Auswertung	Evaluation	Évaluation	digital / digital / Numérique
Umgebungstemperatur Betrieb	Ambient temperature during operation	Température ambiante de fonctionnement	-25 ... +70 °C
Schutzart	Protection type	Indice de protection	IP 67
Anschluss	Connection	Raccordement	Stecker, M12, 3-polig, A-kodiert / Connector, M12, 3-pin, A-coded / Connecteur, M12, 3 pôles, Codage A

Sicherheitshinweise	Safety instructions	Consignes de sécurité
Allgemeiner Sicherheitshinweis WARNUNG! Kein Sicherheitsbauteil gemäß 2006/42/EG und EN 61496-1 /-2! Darf nicht zum Personenschutz eingesetzt werden! Nichtbeachtung kann zu Tod oder schwersten Verletzungen führen! Nur bestimmungsgemäß verwenden!	General safety notice WARNING! Not a safety component pursuant to 2006/42/EG and EN 61496-1/-2! May not be used for personal protection! Non-compliance can lead to death or serious injuries! Only use as directed!	Consigne de sécurité générale AVERTISSEMENT ! Ce produit n'est pas un composant de sécurité au sens des réglementations 2006/42/CE et NF EN 61496-1/-2 ! Ne pas l'utiliser pour la protection des personnes ! Le non-respect de cette consigne peut entraîner la mort ou des blessures graves ! N'utiliser le produit que selon son utilisation conforme !

INS-M30-B15PO-B3

电感式接近传感器



di-soric GmbH & Co. KG
 Steinbeisstraße 6
 DE-73660 Urbach
 Germany
 Tel: +49 (0) 7181/9879-0
 info@di-soric.com · www.di-soric.com

213309



版本 24.07.16, 保留变更权

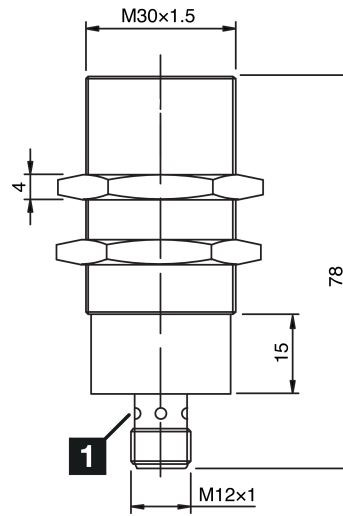

1) LED

mm

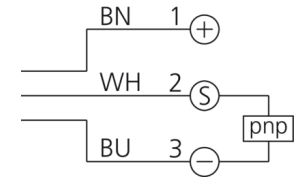

BN : 棕色
 BU : 蓝色

WH: 白色

技术数据

内装方式

感应距离

工作电压

开关输出端

评估

工作环境温度

防护等级

连接

+20°C, 24 V DC

齐平

15 mm

10 ... 30 V DC

pnp, 200 mA, NC

数字量

-25 ... +70 °C

IP 67

插头, M12, 3 针, A 编码

安全提示



一般安全提示

警告！没有符合 2006/42/EU 和 EN 61496-1 /-2 标准的安全结构件！不得用于人身安全保护！不遵守规定会导致死亡或重伤危险！仅按规定使用！