

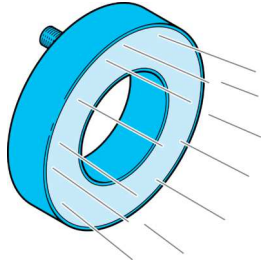

## BEK-R70/120-G5TI-IBS-DIF

环形光源



di-soric GmbH & Co. KG  
 Steinbeisstraße 6  
 DE-73660 Urbach  
 Germany  
 Tel: +49 (0) 7181/9879-0  
 info@di-soric.com · www.di-soric.com

206387

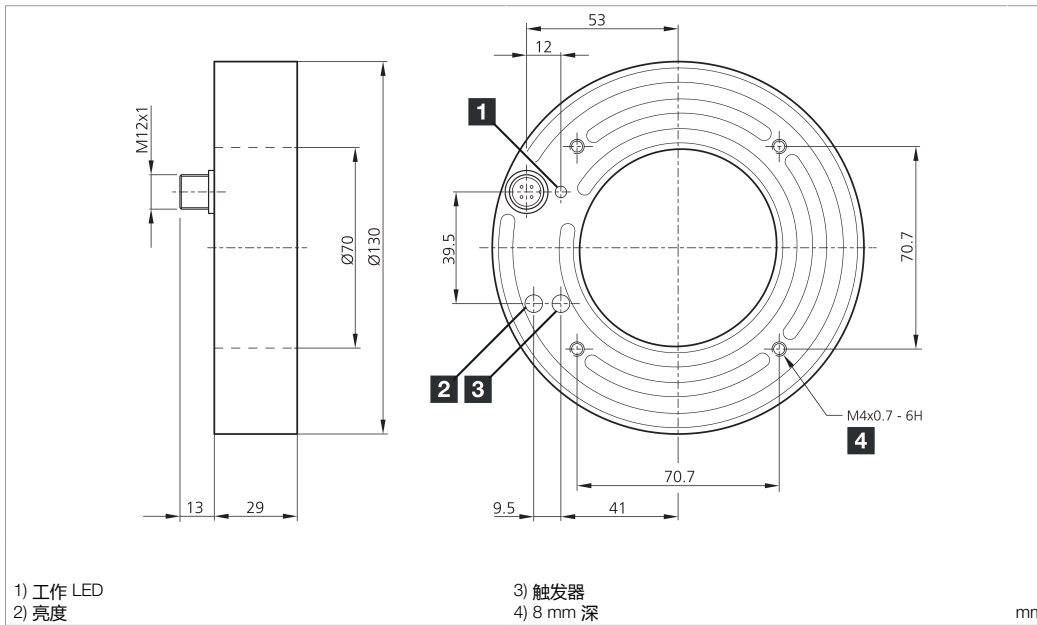

1) 工作 LED  
 2) 亮度

3) 触发器  
 4) 8 mm 深

mm

BK : 黑色  
 BN : 棕色  
 BU : 蓝色

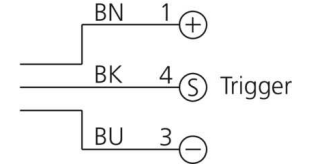

### 技术数据

光色	+20°C, 24 V DC
发射角 FWHM	白色
工作电压	120°
空载电流 (最大)	18 ... 35 V DC (Supply Class 2)
功率	560 mA (18 V DC)
工作环境温度	10 W / 24 V DC
防护等级	0 ... +40 °C
风险组 (DIN EN 62471)	IP 67
	无危险类

版本 24.11.12, 保留变更权

Supply Class 2 Enclosure Type 1

### 安全提示

**一般安全提示**  
 警告！没有符合 2006/42/EU 和 EN 61496-1 /-2 标准的安全结构件！不得用于人身安全保护！不遵守规定会导致死亡或重伤危险！仅按规定使用！

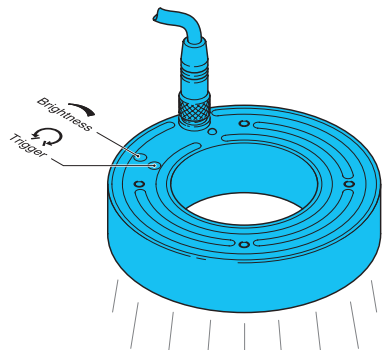

## Ringbeleuchtung

-  Nicht dauerhaft in den Lichtstrahl blicken!

---

-  Diese Beleuchtung erzeugt eine sichtbare oder unsichtbare Strahlung, welche bei dauerhafter Einwirkung schädlich sein kann!

---

-  Wärmekonvektion gewährleisten!  
Die Erwärmung der Beleuchtung hat einen direkten Einfluss auf die Alterung/Lebensdauer der Beleuchtungs-LEDs! Je höher die Temperatur, desto stärker die Alterung.

---

-  - Beleuchtung nicht abdecken  
- Beleuchtungsintensität an die Applikation anpassen (überschüssige Lichtstärke vermeiden)  
- Dauerlicht reduzieren/vermeiden (Triggerfunktion nutzen)  
- Beleuchtung bei längerer Nichtnutzung abschalten

---

-  Betriebswärme folgendermaßen abführen:  
- Montage an eine kühlende Fläche (Maschinenkörper)  
- Montage an einen externen Kühlkörper

---

-  Regelmäßige Reinigung!  
Starke Verschmutzung verhindert den Lichtaustritt und erhöht die Wärmeentwicklung.

## Ringlight

-  Do not look into the light beam for a prolonged period of time!

---

-  This light produces radiation which may or may not be visible and prolonged exposure may be harmful!

---

-  Ensure heat convection!  
The heating of the light has a direct impact on the ageing/lifetime of the light LEDs! The higher the temperature, the faster the ageing process.

---

-  - Do not cover the light  
- Adapt the light intensity to the application (avoid excessive light intensity)  
- Reduce/avoid continuous light (use trigger function)  
- Switch off light when it is not being used for longer periods of time

---

-  Dissipate operating heat as follows:  
- Install on a cool surface (machine structure)  
- Install on an external cooling element

---

-  Clean on a regular basis!  
Heavy contamination prevents light emission and increases heat development.

## Anneau lumineux

-  Ne pas regarder le rayon lumineux pendant une période de temps prolongée!

---

-  Cette lumière produit des radiations qui pourraient ou ne pourraient pas être visibles et une exposition prolongée peut être nuisible!

---

-  Protéger de l'émission de chaleur!  
La chaleur émise par la lumière a un effet direct sur le vieillissement/la durée de vie des LED! Plus la température s'élève, plus rapide est le processus de vieillissement.

---

-  - Ne pas couvrir la lumière  
- Adapter l'intensité lumineuse en fonction de la nécessité de l'application (éviter l'excès d'intensité lumineuse)  
- Réduire/éviter l'éclairage continu (utiliser la fonction de déclenchement)  
- Éteindre l'éclairage lorsqu'il n'est pas utilisé pendant de longues périodes

---

-  Dissiper la chaleur d'émission comme suit:  
- Installer sur une surface froide (structure de la machine)  
- Installer sur un élément refroidissant externe

---

-  Nettoyer régulièrement  
L'encrassement entrave la bonne émission de l'éclairage et accroît l'émission de chaleur.