

SH-WKA-10-10-60

Winkelarm
Angle arm
Bras d'équerrage

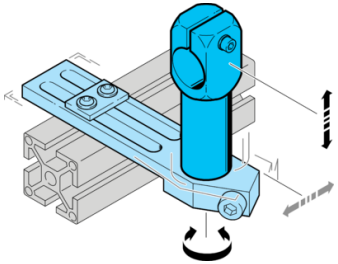

di-soric GmbH & Co. KG
Steinbeisstraße 6
DE-73660 Urbach
Germany
Tel: +49 (0) 7181/9879-0
info@di-soric.com · www.di-soric.com

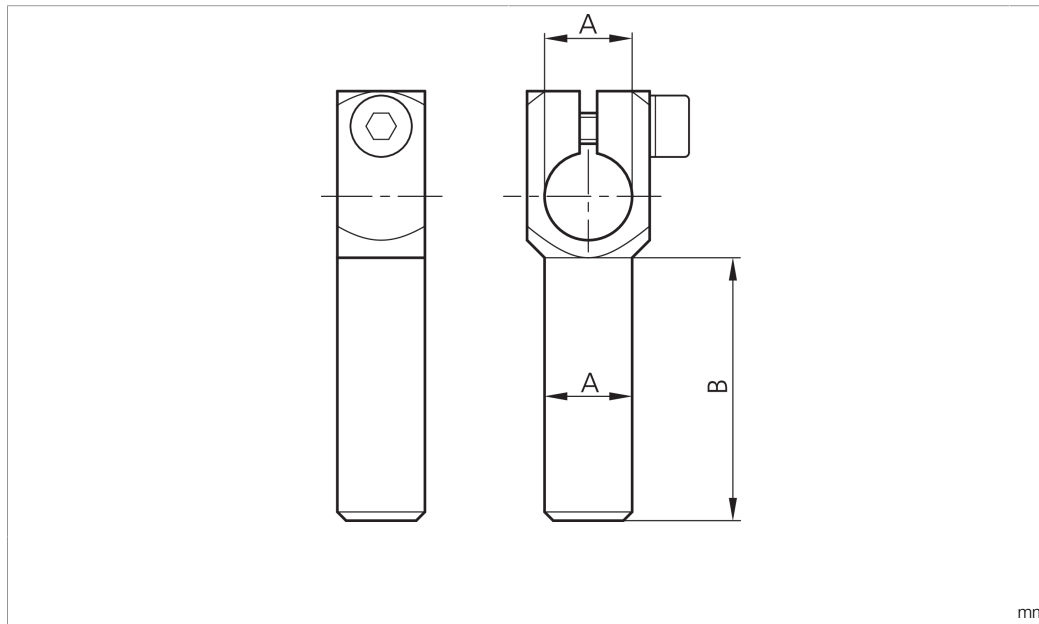

Technische Daten	Technical data	Caractéristiques techniques	+20°C
Produktserie	Product series	Gamme de produits	Z-UBT-KL-MS Montagesystem / Z-UBT-KL-MS Assembly system / Système de montage Z-UBT-KL-MS
Geeignet für	To be used for	Convient pour	Klemmbolzen 10 mm / Clamping pin 10 mm / Boulon de serrage 10 mm
Durchmesser A	Diameter A	Diamètre A	10 mm
Maß B	Dimension B	Dimension B	60 mm
Material	Material	Matériau	Metall / Metal / Métal

Stand 16.07.24, Änderungen vorbehalten
As of 07/16/24, subject to change
État 16.07.24, sous réserve de modifications



SH-WKA-10-10-60

角臂

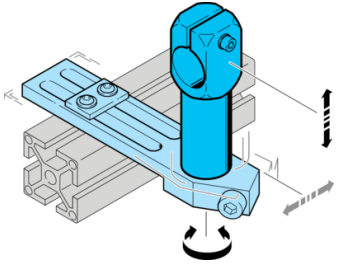

di-soric GmbH & Co. KG
 Steinbeisstraße 6
 DE-73660 Urbach
 Germany
 Tel: +49 (0) 7181/9879-0
 info@di-soric.com · www.di-soric.com

203893

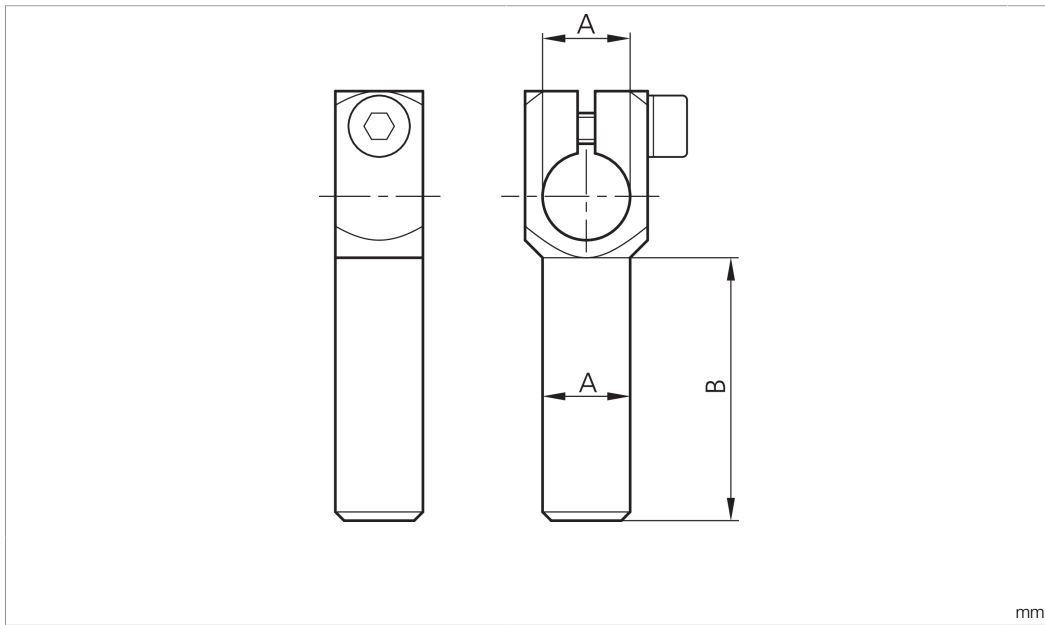

技术数据

产品系列

适合用于

直径 A

尺寸 B

材料

+20°C

Z-UBT-KL-MS 安装系统

夹紧螺栓 10 mm

10 mm

60 mm

金属

版本 24.07.16, 保留变更权