

SH-WST-L-10-U

Winkelklemmstück
 Angle clamp
 Élément de fixation d'angle

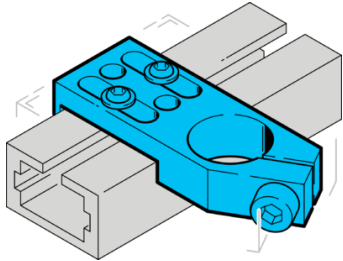

di-soric GmbH & Co. KG
 Steinbeisstraße 6
 DE-73660 Urbach
 Germany
 Tel: +49 (0) 7181/9879-0
 info@di-soric.com · www.di-soric.com

203889

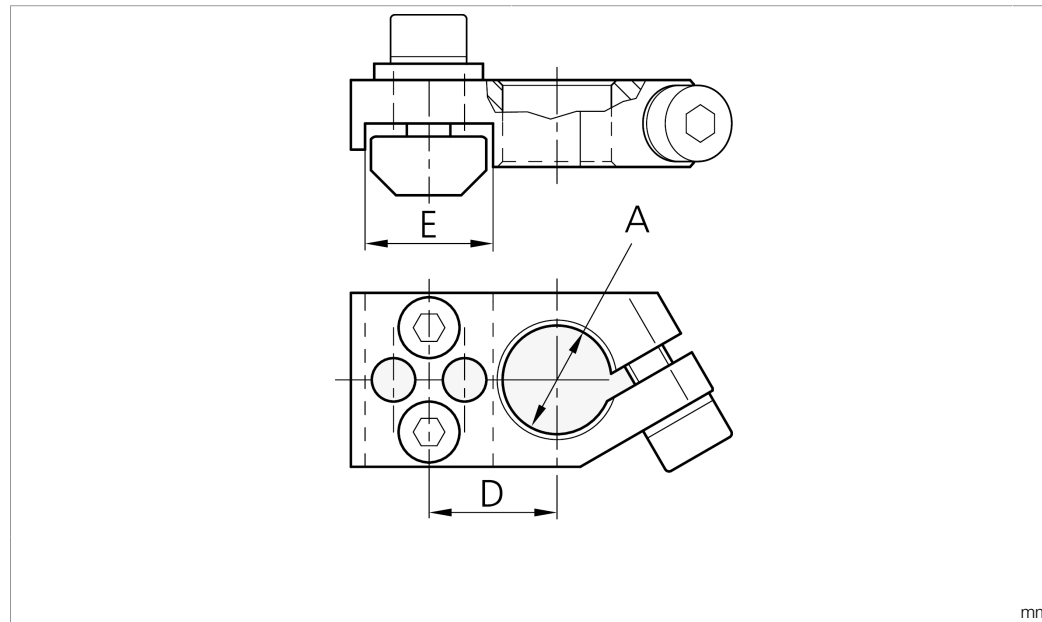

Technische Daten	Technical data	Caractéristiques techniques	+20°C
Produktserie	Product series	Gamme de produits	Z-UBT-KL-MS Montagesystem / Z-UBT-KL-MS Assembly system / Système de montage Z-UBT-KL-MS
Geeignet für	To be used for	Convient pour	Klemmbolzen 10 mm / Clamping pin 10 mm / Boulon de serrage 10 mm
Durchmesser A	Diameter A	Diamètre A	10 mm
Abstandsmaß D	Distance dimension D	Mesure de distance D	16 mm
Abstandsmaß E	Distance dimension E	Mesure de distance E	18 mm
Material	Material	Matériau	Metall / Metal / Métal

Stand 16.07.24, Änderungen vorbehalten
 As of 07/16/24, subject to change
 État 16.07.24, sous réserve de modifications



SH-WST-L-10-U

角夹

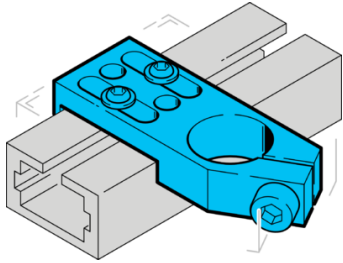

di-soric GmbH & Co. KG
 Steinbeisstraße 6
 DE-73660 Urbach
 Germany
 Tel: +49 (0) 7181/9879-0
 info@di-soric.com · www.di-soric.com

203889

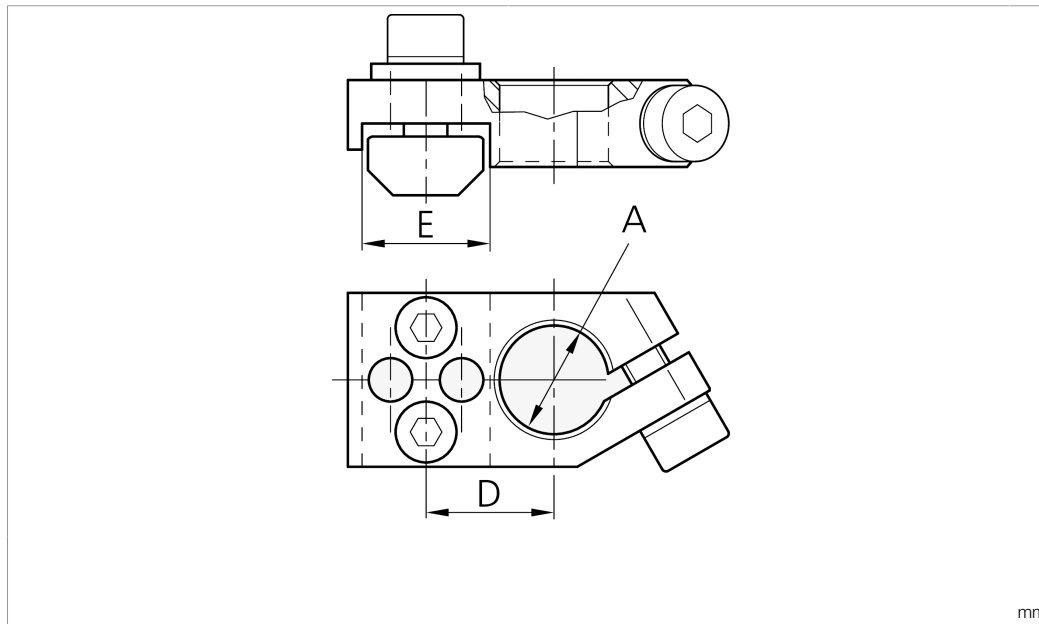

技术数据	+20°C
产品系列	Z-UBT-KL-MS 安装系统
适合用于	夹紧螺栓 10 mm
直径 A	10 mm
距离尺寸 D	16 mm
距离尺寸 E	18 mm
材料	金属

版本 24.07.16, 保留变更权