

BE-F30/30RL-G1-K-BS

Flächenbeleuchtung
Area light
Éclairage de surfaces

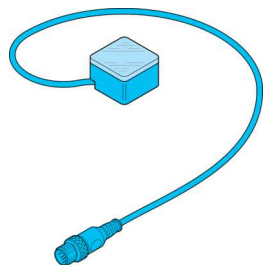

di-soric GmbH & Co. KG
Steinbeisstraße 6
DE-73660 Urbach
Germany
Tel: +49 (0) 7181/9879-0
info@di-soric.com · www.di-soric.com

209699

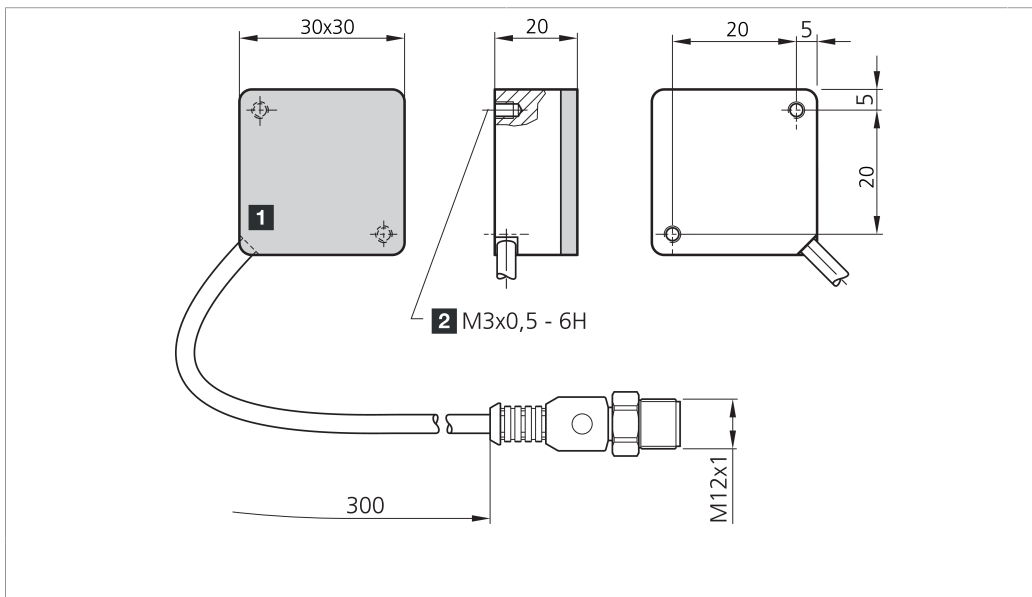

1) Leuchtfläche / Illuminated area / Surface d'éclairage 2) 4.5 mm tief / 4.5 mm deep / 4.5 mm de profondeur mm

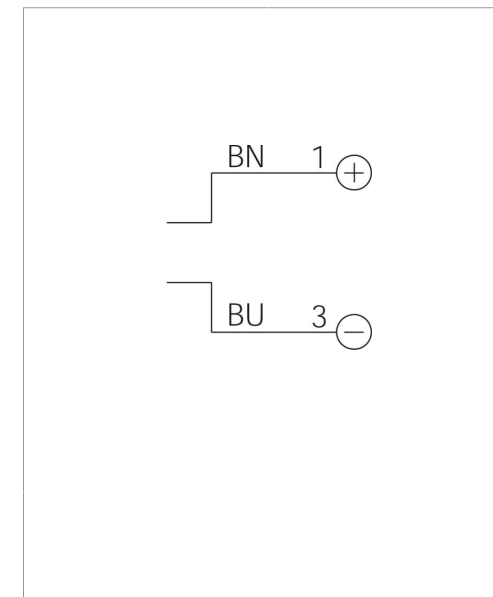

BN : braun / brown / marron BU : blau / blue / bleu

Stand 22.10.24, Änderungen vorbehalten
As of 10/22/24, subject to change
État 22.10.24, sous réserve de modifications

Technische Daten	Technical data	Caractéristiques techniques	+20°C, 24 V DC
Leuchtfläche	Illuminated area	Surface d'éclairage	30 x 30 mm
Betriebsspannung	Service voltage	Tension de service	24 V DC (Supply Class 2)
Leerlaufstrom (max.)	No-load current (max.)	Courant de marche à vide (max.)	50 mA (24 V DC)
Leistung	Power	Puissance	1,2 W / 24 V DC / 1,2 W / 24 V DC / 1,2 W / 24 V DC
Umgebungstemperatur Betrieb	Ambient temperature during operation	Température ambiante de fonctionnement	0 ... +40 °C
Schutzart	Protection type	Indice de protection	IP 67
Risikogruppe (DIN EN 62471)	Risk group (DIN EN 62471)	Groupe de risque (DIN EN 62471)	Freie Gruppe / Free group / Groupe libre
Schutzklasse	Protection class	Classe de protection	III, Betrieb an Schutzkleinspannung / III, operation on protective low voltage / III, utilisation en très basse tension de sécurité

Supply Class 2 Enclosure Type 1
 NFPA 79 Applications only. For ad-
 apters providing field wiring me-
 ans refer to product information or
 customer support.
 IND. CONT. EQ.
 29W7

Sicherheitshinweise	Safety instructions	Consignes de sécurité
Allgemeiner Sicherheitshinweis WARNUNG! Kein Sicherheitsbauteil gemäß 2006/42/EG und EN 61496-1 /-2! Darf nicht zum Personenschutz eingesetzt werden! Nichtbeachtung kann zu Tod oder schwersten Verletzungen führen! Nur bestimmungsgemäß verwenden!	General safety notice WARNING! Not a safety component pursuant to 2006/42/EG and EN 61496-1/-2! May not be used for personal protection! Non-compliance can lead to death or serious injuries! Only use as directed!	Consigne de sécurité générale AVERTISSEMENT ! Ce produit n'est pas un composant de sécurité au sens des réglementations 2006/42/CE et NF EN 61496-1/-2 ! Ne pas l'utiliser pour la protection des personnes ! Le non-respect de cette consigne peut entraîner la mort ou des blessures graves ! N'utiliser le produit que selon son utilisation conforme !

di-soric

BE-F30/30RL-G1-K-BS

背光源

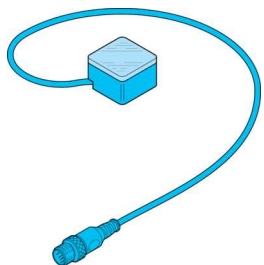

di-soric GmbH & Co. KG
 Steinbeisstraße 6
 DE-73660 Urbach
 Germany
 Tel: +49 (0) 7181/9879-0
 info@di-soric.com · www.di-soric.com

209699



版本 24.10.22, 保留变更权

UL LISTED
 IND. CONT. EQ. 29W7

Supply Class 2 Enclosure Type 1
 NFPA 79 Applications only. For ad-
 apters providing field wiring me-
 ans refer to product information or
 customer support.

CE UK CA

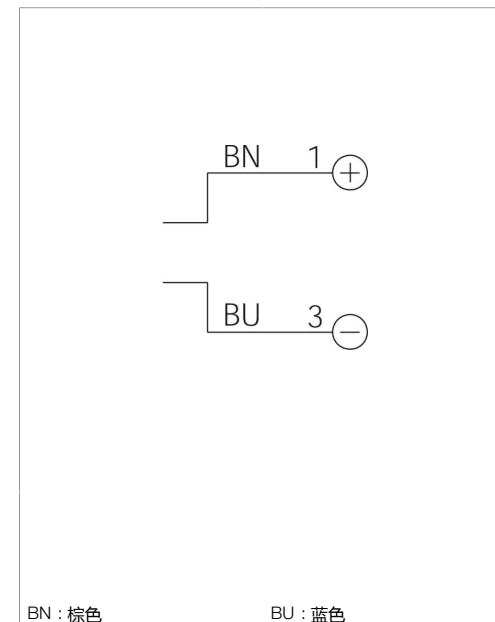
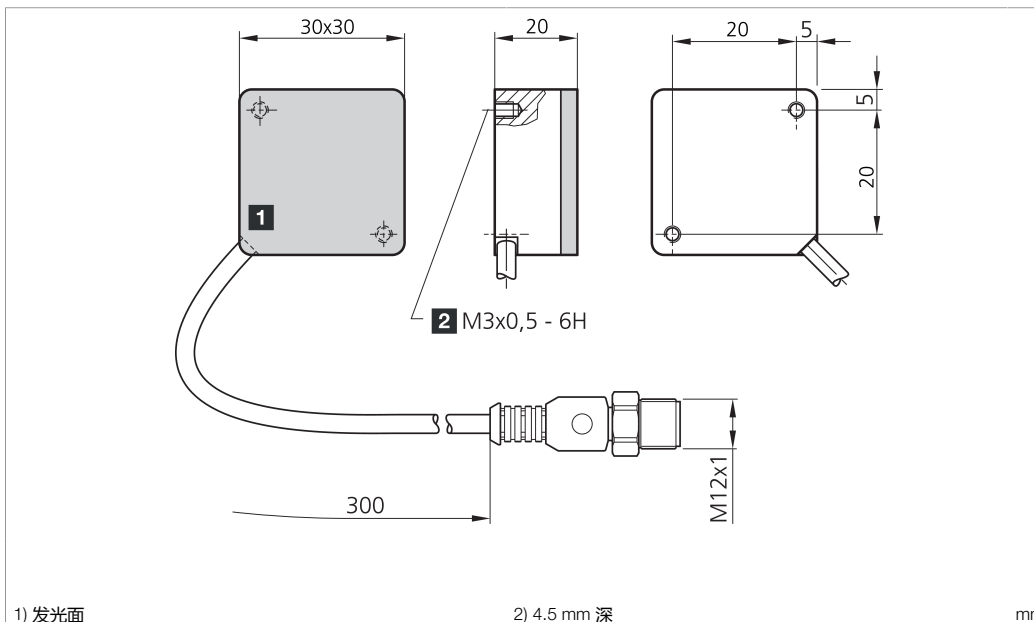

技术数据	+20°C, 24 V DC
发光面	30 x 30 mm
工作电压	24 V DC (Supply Class 2)
空载电流 (最大)	50 mA (24 V DC)
功率	1.2 W / 24 V DC
工作环境温度	0 ... +40 °C
防护等级	IP 67
风险组 (DIN EN 62471)	无危险类
防护等级	III, 在安全特低电压下工作

安全提示

一般安全提示
 警告！没有符合 2006/42/EU 和 EN 61496-1 /-2 标准的安全结构件！不得用于人身安全保护！不遵守规定会导致死亡或重伤危险！仅按规定使用！

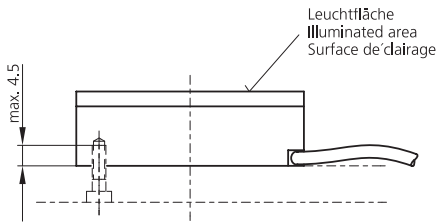



Flächenbeleuchtung

Backlight

Rétro-éclairages

 Maximale Gewindetiefe beachten!

 Please observe maximum thread depth!

 S'il vous plaît respecter profondeur de filetage maximum!

 Nicht dauerhaft in den Lichtstrahl blicken!

 Do not look into the light beam for a prolonged period of time!

 Ne pas regarder le rayon lumineux pendant une période de temps prolongée!

 Diese Beleuchtung erzeugt eine sichtbare oder unsichtbare Strahlung, welche bei dauerhafter Einwirkung schädlich sein kann!

 This light produces radiation which may or may not be visible and prolonged exposure may be harmful!

 Cette lumière produit des radiations qui pourraient ou ne pourraient pas être visibles et une exposition prolongée peut être nuisible!

 Wärmekonvektion gewährleisten!
Die Erwärmung der Beleuchtung hat einen direkten Einfluss auf die Alterung/Lebensdauer der Beleuchtungs-LEDs! Je höher die Temperatur, desto stärker die Alterung.

 Ensure heat convection!
The heating of the light has a direct impact on the ageing/lifetime of the light LEDs! The higher the temperature, the faster the ageing process.

 Protéger de l'émission de chaleur!
La chaleur émise par la lumière a un effet direct sur le vieillissement/la durée de vie des LED! Plus la température s'élève, plus rapide est le processus de vieillissement

 - Beleuchtung nicht abdecken
- Beleuchtung bei längerer Nichtnutzung abschalten

 - Do not cover the light
- Switch off light when it is not being used for longer periods of time

 - Ne pas couvrir la lumière
- Éteindre l'éclairage lorsqu'il n'est pas utilisé pendant de longues périodes

 Betriebswärme folgendermaßen abführen:
- Montage an eine kühlende Fläche (Maschinenkörper)
- Montage an einen externen Kühlkörper

 Dissipate operating heat as follows:
- Install on a cool surface (machine structure)
- Install on an external cooling element

 Dissiper la chaleur d'émission comme suit:
- Installer sur une surface froide (structure de la machine)
- Installer sur un élément refroidissant externe

 Regelmäßige Reinigung!
Starke Verschmutzung verhindert den Lichtaustritt und erhöht die Wärmeentwicklung.

 Clean on a regular basis!
Heavy contamination prevents light emission and increases heat development.

 Nettoyer régulièrement
L'encrassement entrave la bonne émission de l'éclairage et accroît l'émission de chaleur

