

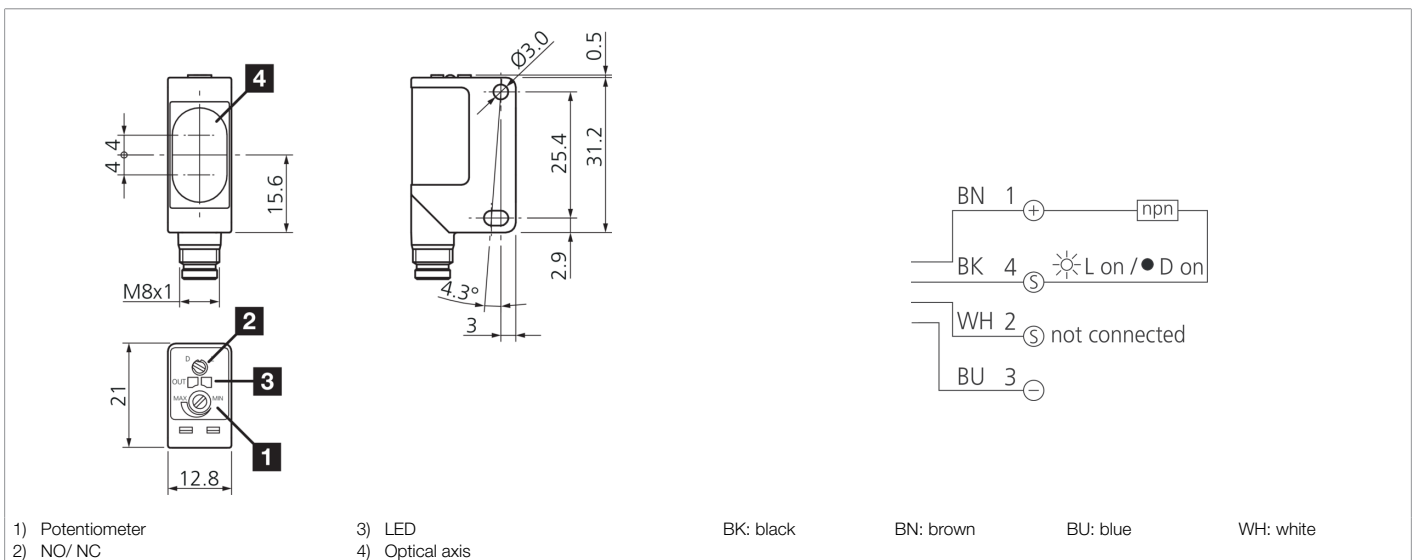

209266
OR 31 K 1500 N3-T4
Retroreflective sensor

- Detection of transparent objects
- Compact design
- Red light
- Sensitivity is adjustable
- Switch for light/dark switching
- Long range
- Fully molded electronic circuitry, vibration-resistant
- Standardized hole spacing 25.4 mm



Function										

Technical data (typ.)	+20°C, 24 V DC
Service voltage	10 ... 30 V DC
No-load current (max.)	30 mA
Insulation voltage endurance	500 V
Housing dimensions	31.2 x 21 x 12.8 mm
Housing length	21 mm
Housing height	31.2 mm
Housing width	12.8 mm
Housing material	Plastic (PA, 6.6)
Material	PMMA (Window)
Protection class	III, operation on protective low voltage
Operating principle	Retroreflective sensor
Evaluation	digital
Design	Cuboid design
Switching output	npn, 100 mA, NO/NC, switchable
Voltage drop (max.)	2 V
Light source	LED
Color	Red
Wavelength	630 nm
Modulation	Clocked



209266
OR 31 K 1500 N3-T4
Retroreflective sensor

Technical data (typ.)	+20°C, 24 V DC
Ambient light immunity	3 kLx Halogen light, 10 kLx Sunlight
Range	50 ... 1500 mm
Referring reflector	Ø 84 mm, R 84
Switching hysteresis (max.)	10 %
Sensitivity adjustment	Potentiometer
Switching frequency	2000 Hz
Response time	0.25 ms
Release time	0.25 ms
Ambient temperature during operation	-25 ... +70 °C
Temperature drift	1.5 mm/K
Protection type	IP 67
Connection	Connector, M8, 4-pin
Connection cable	TK ... /4
More information / accessories	https://www.di-soric.com/209266