

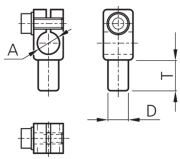

203916
SH-8-10
Sensor holder Ø 8mm

- Highly flexible versatile mounting system
- Universal mounting
- Stepless adjustment
- Robust design

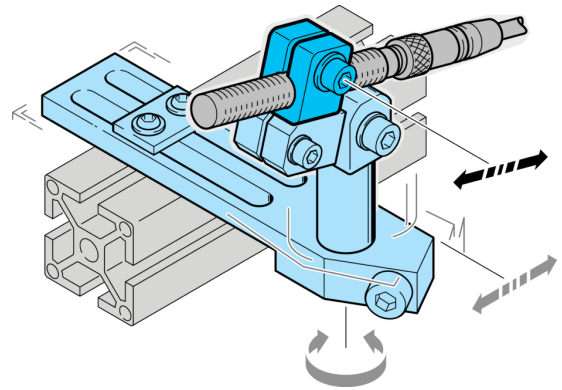

A	D	T	
4	10	16	SH-4-10
5	10	16	SH-5-10
6,5	10	16	SH-6.5-10
8	10	16	SH-8-10
12	10	16	SH-12-10
18	14	20	SH-18-14
30	20	26	SH-30-20

Technical data (typ.)

Diameter	+20°C A: 8.0 mm
Distance dimension	D: 10 mm
Housing material	Plastic (PA)
Component	Sensor holder
To be used for	Clamping pin 10 mm
Product series	Z-UBT-KL-PH Product bracket

More information / accessories

<https://www.di-soric.com/203916>