

## BEK-K50/50-G5TI-IBS

Koaxialbeleuchtung  
Coaxial light  
Éclairage coaxial

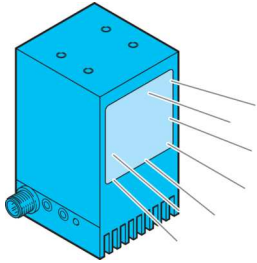

di-soric GmbH & Co. KG  
Steinbeisstraße 6  
DE-73660 Urbach  
Germany  
Tel: +49 (0) 7181/9879-0  
info@di-soric.com · www.di-soric.com

206857

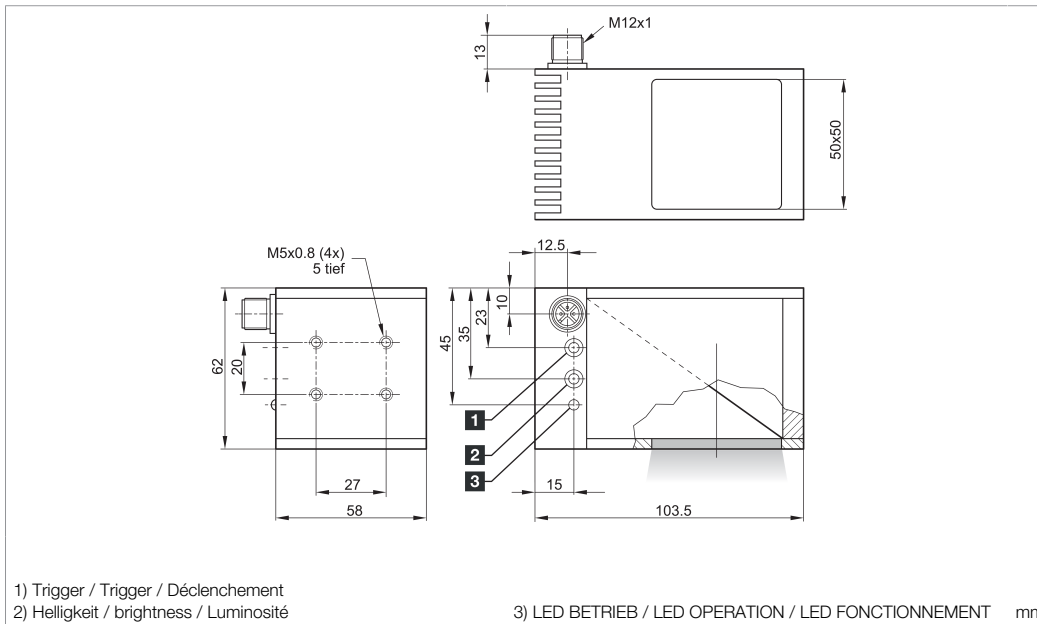

1) Trigger / Trigger / Déclenchement  
2) Helligkeit / brightness / Luminosité

3) LED BETRIEB / LED OPERATION / LED FONCTIONNEMENT mm

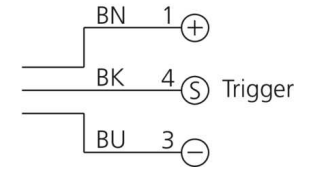





BK : schwarz / black / noir  
BN : braun / brown / marron BU : blau / blue / bleu



Technische Daten	Technical data	Caractéristiques techniques	+20°C, 24 V DC
Betriebsspannung	Service voltage	Tension de service	18 ... 35 V DC (Supply Class 2)
Leerlaufstrom (max.)	No-load current (max.)	Courant de marche à vide (max.)	310 mA (24 V DC)
Leistung	Power	Puissance	7,4 W / 24 V DC / 7,4 W / 24 V DC / 7,4 W / 24 V DC
Umgebungstemperatur Betrieb	Ambient temperature during operation	Température ambiante de fonctionnement	0 ... +40 °C
Schutzart	Protection type	Indice de protection	IP 20
Risikogruppe (DIN EN 62471)	Risk group (DIN EN 62471)	Groupe de risque (DIN EN 62471)	Freie Gruppe / Free group / Groupe libre
Schutzklasse	Protection class	Classe de protection	III, Betrieb an Schutzkleinspannung / III, operation on protective low voltage / III, utilisation en très basse tension de sécurité

Stand 22.10.24, Änderungen vorbehalten

As of 10/22/24, subject to change

État 22.10.24, sous réserve de modifications

 Supply Class 2 Enclosure Type 1  
 NFPA 79 Applications only. For ad-  
 apters providing field wiring me-  
 ans refer to product information or  
 customer support.  
 IND. CONT. EQ.  
 29W7  



Sicherheitshinweise	Safety instructions	Consignes de sécurité
 <b>Allgemeiner Sicherheitshinweis</b> WARNUNG! Kein Sicherheitsbauteil gemäß 2006/42/EG und EN 61496-1 /-2! Darf nicht zum Personenschutz eingesetzt werden! Nichtbeachtung kann zu Tod oder schwersten Verletzungen führen! Nur bestimmungsgemäß verwenden!	 <b>General safety notice</b> WARNING! Not a safety component pursuant to 2006/42/EG and EN 61496-1/-2! May not be used for personal protection! Non-compliance can lead to death or serious injuries! Only use as directed!	 <b>Consigne de sécurité générale</b> AVERTISSEMENT ! Ce produit n'est pas un composant de sécurité au sens des réglementations 2006/42/CE et NF EN 61496-1/-2 ! Ne pas l'utiliser pour la protection des personnes ! Le non-respect de cette consigne peut entraîner la mort ou des blessures graves ! N'utiliser le produit que selon son utilisation conforme !

## BEK-K50/50-G5TI-IBS

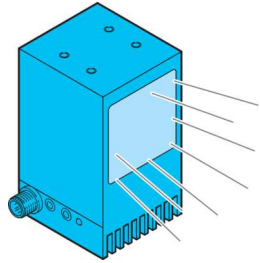
同轴光源



di-soric GmbH & Co. KG  
 Steinbeisstraße 6  
 DE-73660 Urbach  
 Germany  
 Tel: +49 (0) 7181/9879-0  
 info@di-soric.com · www.di-soric.com

206857

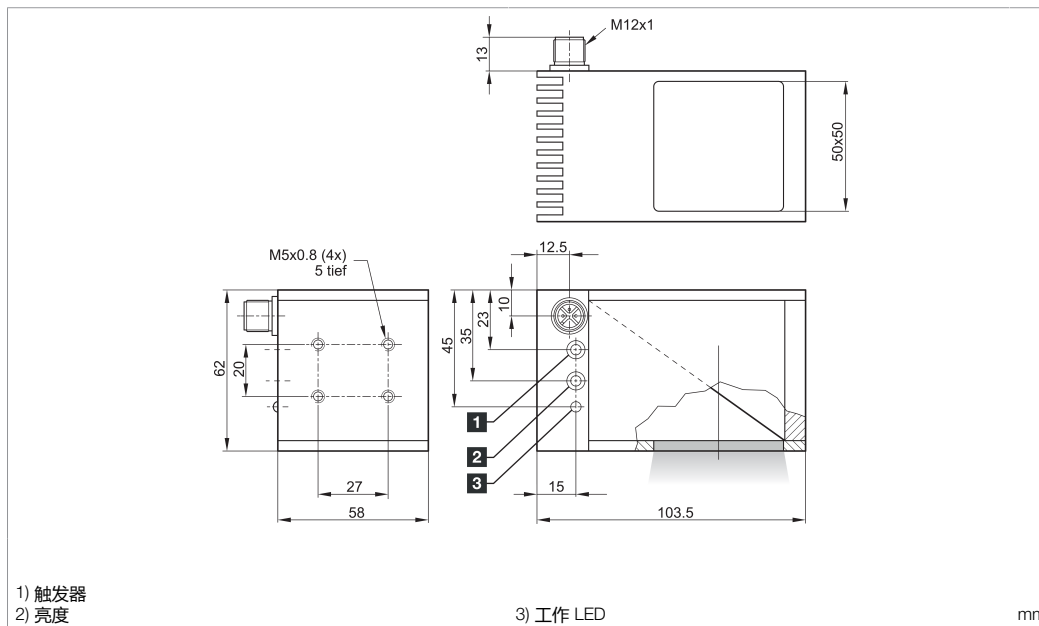

1) 触发器  
 2) 亮度

3) 工作 LED

mm

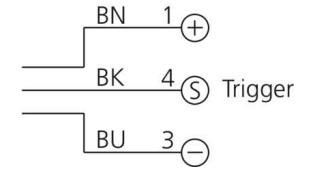

BK : 黑色  
 BN : 棕色

BU : 蓝色

### 技术数据

工作电压

空载电流 (最大)

功率

工作环境温度

防护等级

风险组 (DIN EN 62471)

防护等级

**+20°C, 24 V DC**

18 ... 35 V DC (Supply Class 2)

310 mA (24 V DC)

7.4 W / 24 V DC

0 ... +40 °C

IP 20

无危险类

III, 在安全特低电压下工作

版本 24.10.22, 保留变更权



Supply Class 2 Enclosure Type 1  
 NFPA 79 Applications only. For ad-  
 apters providing field wiring me-  
 ans refer to product information or  
 customer support.

### 安全提示



#### 一般安全提示

警告！没有符合 2006/42/EU 和 EN 61496-1 /-2 标准的安全结构件！不得用于人身安全保护！不遵守规定会导致死亡或重伤危险！仅按规定使用！



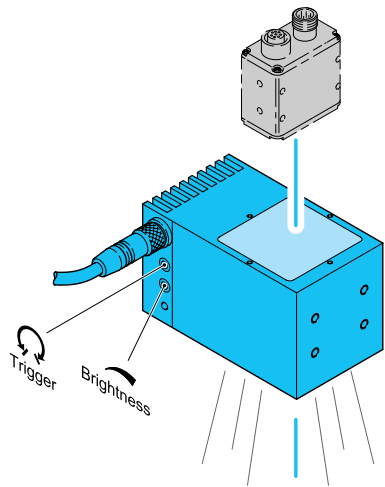

## Koaxialbeleuchtung

## Coaxial Light

## Éclairages coaxial



Nicht dauerhaft in den Lichtstrahl blicken!



Do not look into the light beam for a prolonged period of time!



Ne pas regarder le rayon lumineux pendant une période de temps prolongée!



Diese Beleuchtung erzeugt eine sichtbare oder unsichtbare Strahlung, welche bei dauerhafter Einwirkung schädlich sein kann!



This light produces radiation which may or may not be visible and prolonged exposure may be harmful!



Cette lumière produit des radiations qui pourraient ou ne pourraient pas être visibles et une exposition prolongée peut être nuisible!



Wärme Konvektion gewährleisten!



Ensure heat convection!



Protéger de l'émission de chaleur!

Die Erwärmung der Beleuchtung hat einen direkten Einfluss auf die Alterung/Lebensdauer der Beleuchtungs-LEDs! Je höher die Temperatur, desto stärker die Alterung.

The heating of the light has a direct impact on the ageing/lifetime of the light LEDs! The higher the temperature, the faster the ageing process.

La chaleur émise par la lumière a un effet direct sur le vieillissement/la durée de vie des LED! Plus la température s'élève, plus rapide est le processus de vieillissement.s



- Beleuchtung nicht abdecken



- Do not cover the light



- Ne pas couvrir la lumière

- Beleuchtungsintensität an die Applikation anpassen (überschüssige Lichtstärke vermeiden)

- Adapt the light intensity to the application (avoid excessive light intensity)

- Adapter l'intensité lumineuse en fonction de la nécessité de l'application (éviter l'excès d'intensité lumineuse)

- Dauerlicht reduzieren/vermeiden (Triggerfunktion nutzen)

- Reduce/avoid continuous light (use trigger function)

- Réduire/éviter l'éclairage continu (utiliser la fonction de déclenchement)

- Beleuchtung bei längerer Nichtnutzung abschalten

- Switch off light when it is not being used for longer periods of time

- Éteindre l'éclairage lorsqu'il n'est pas utilisé pendant de longues périodes



Betriebswärme folgendermaßen abführen:



Dissipate operating heat as follows:



Dissiper la chaleur d'émission comme suit:

- Montage an eine kühlende Fläche (Maschinenkörper)

- Install on a cool surface (machine structure)

- Installer sur une surface froide (structure de la machine)

- Montage an einen externen Kühlkörper

- Install on an external cooling element

- Installer sur un élément refroidissant externe



Regelmäßige Reinigung!



Clean on a regular basis!



Nettoyer régulièrement

Starke Verschmutzung verhindert den Lichtaustritt und erhöht die Wärmeentwicklung.

Heavy contamination prevents light emission and increases heat development.

L'encrassement entrave la bonne émission de l'éclairage et accroît l'émission de chaleur.