

BEK-R70/30-G0TI-IBS-DIF

Ringbeleuchtung
Ringlight
Anneau lumineux

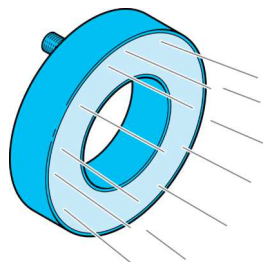

di-soric GmbH & Co. KG
Steinbeisstraße 6
DE-73660 Urbach
Germany
Tel: +49 (0) 7181/9879-0
info@di-soric.com · www.di-soric.com

206466

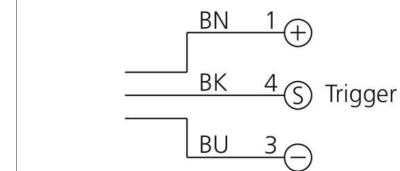
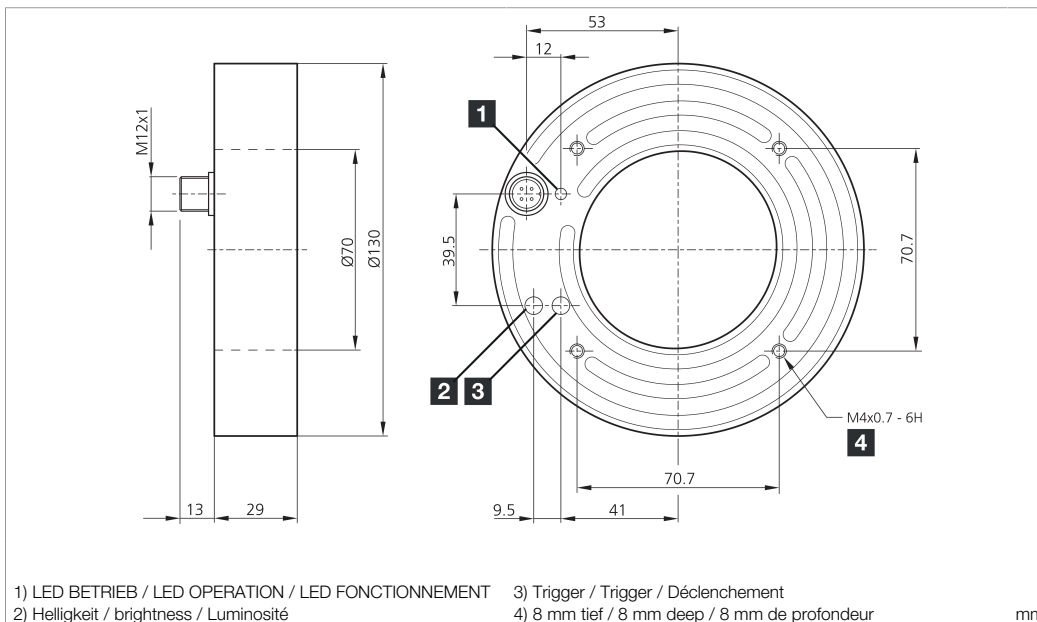

BK : schwarz / black / noir
BN : braun / brown / marron BU : blau / blue / bleu

Technische Daten	Technical data	Caractéristiques techniques	+20°C, 24 V DC
Lichtfarbe	Light color	Couleur de lumière	Infrarot / Infrared / Infrarouge
Abstrahlwinkel FWHM	Deflection angle FWHM	Angle d'émission FWHM	30°
Betriebsspannung	Service voltage	Tension de service	18 ... 35 V DC (Supply Class 2)
Leerlaufstrom (max.)	No-load current (max.)	Courant de marche à vide (max.)	370 mA (24 V DC)
Leistung	Power	Puissance	8,9 W / 24 V DC / 8,9 W / 24 V DC / 8,9 W / 24 V DC
Umgebungstemperatur Betrieb	Ambient temperature during operation	Température ambiante de fonctionnement	0 ... +40 °C
Schutzart	Protection type	Indice de protection	IP 67
Risikogruppe (DIN EN 62471)	Risk group (DIN EN 62471)	Groupe de risque (DIN EN 62471)	Freie Gruppe / Free group / Groupe libre

Stand 22.10.24, Änderungen vorbehalten

As of 10/22/24, subject to change

État 22.10.24, sous réserve de modifications



Supply Class 2 Enclosure Type 1
NFPA 79 Applications only. For ad-
apters providing field wiring me-
ans refer to product information or
customer support.



Sicherheitshinweise



Allgemeiner Sicherheitshinweis

WARNUNG! Kein Sicherheitsbauteil gemäß 2006/42/
EG und EN 61496-1 /-2! Darf nicht zum Person-
enschutz eingesetzt werden! Nichtbeachtung kann zu
Tod oder schwersten Verletzungen führen! Nur bestim-
mungsgemäß verwenden!

Safety instructions



General safety notice

WARNING! Not a safety component pursuant to
2006/42/EG and EN 61496-1/-2! May not be used for
personal protection! Non-compliance can lead to death
or serious injuries! Only use as directed!

Consignes de sécurité



Consigne de sécurité générale

AVERTISSEMENT ! Ce produit n'est pas un composant
de sécurité au sens des réglementations 2006/42/CE
et NF EN 61496-1/-2 ! Ne pas l'utiliser pour la protec-
tion des personnes ! Le non-respect de cette consigne
peut entraîner la mort ou des blessures graves ! N'utili-
ser le produit que selon son utilisation conforme !

BEK-R70/30-G0TI-IBS-DIF

环形光源

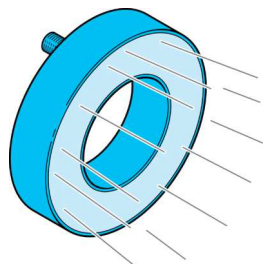

di-soric GmbH & Co. KG
Steinbeisstraße 6
DE-73660 Urbach
Germany
Tel: +49 (0) 7181/9879-0
info@di-soric.com · www.di-soric.com

206466

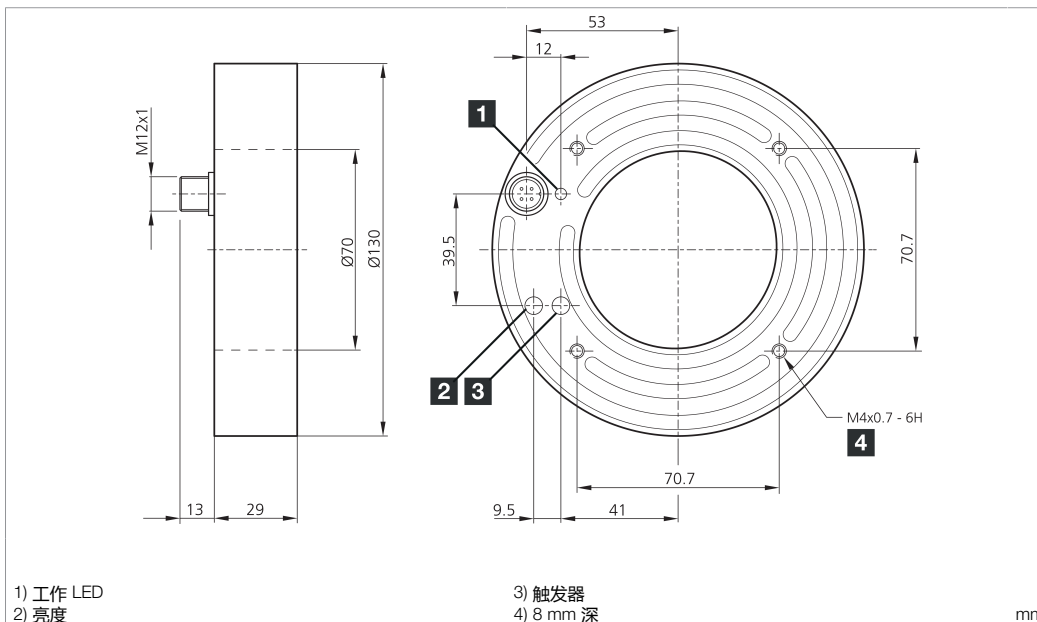

1) 工作 LED
2) 亮度

3) 触发器
4) 8 mm 深

mm

BK : 黑色
BN : 棕色

BU : 蓝色

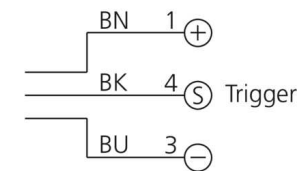

技术数据

光色

发射角 FWHM

工作电压

空载电流 (最大)

功率

工作环境温度

防护等级

风险组 (DIN EN 62471)

+20°C, 24 V DC

红外

30°

18 ... 35 V DC (Supply Class 2)

370 mA (24 V DC)

8.9 W / 24 V DC

0 ... +40 °C

IP 67

无危险类

版本 24.10.22, 保留变更权



Supply Class 2 Enclosure Type 1
NFPA 79 Applications only. For ad-
apters providing field wiring me-
ans refer to product information or
customer support.

安全提示



一般安全提示

警告！没有符合 2006/42/EU 和 EN 61496-1 /-2 标准
的安全结构件！不得用于人身安全保护！不遵守规定
会导致死亡或重伤危险！仅按规定使用！







Ringbeleuchtung

-  Nicht dauerhaft in den Lichtstrahl blicken!

-  Diese Beleuchtung erzeugt eine sichtbare oder unsichtbare Strahlung, welche bei dauerhafter Einwirkung schädlich sein kann!

-  Wärmekonvektion gewährleisten!

Die Erwärmung der Beleuchtung hat einen direkten Einfluss auf die Alterung/Lebensdauer der Beleuchtungs-LEDs! Je höher die Temperatur, desto stärker die Alterung.

-  - Beleuchtung nicht abdecken

 - Beleuchtungsintensität an die Applikation anpassen (überschüssige Lichtstärke vermeiden)
 - Dauerlicht reduzieren/vermeiden (Triggerfunktion nutzen)
 - Beleuchtung bei längerer Nichtnutzung abschalten

-  Betriebswärme folgendermaßen abführen:

 - Montage an eine kühlende Fläche (Maschinenkörper)
 - Montage an einen externen Kühlkörper

-  Regelmäßige Reinigung!

Starke Verschmutzung verhindert den Lichtaustritt und erhöht die Wärmeentwicklung.

Ringlight

-  Do not look into the light beam for a prolonged period of time!

-  This light produces radiation which may or may not be visible and prolonged exposure may be harmful!

-  Ensure heat convection!

The heating of the light has a direct impact on the ageing/lifetime of the light LEDs! The higher the temperature, the faster the ageing process.

-  - Do not cover the light

 - Adapt the light intensity to the application (avoid excessive light intensity)
 - Reduce/avoid continuous light (use trigger function)
 - Switch off light when it is not being used for longer periods of time

-  Dissipate operating heat as follows:

 - Install on a cool surface (machine structure)
 - Install on an external cooling element

-  Clean on a regular basis!

Heavy contamination prevents light emission and increases heat development.

Anneau lumineux

-  Ne pas regarder le rayon lumineux pendant une période de temps prolongée!

-  Cette lumière produit des radiations qui pourraient ou ne pourraient pas être visibles et une exposition prolongée peut être nuisible!

-  Protéger de l'émission de chaleur!

La chaleur émise par la lumière a un effet direct sur le vieillissement/la durée de vie des LED! Plus la température s'élève, plus rapide est le processus de vieillissement.

-  - Ne pas couvrir la lumière

 - Adapter l'intensité lumineuse en fonction de la nécessité de l'application (éviter l'excès d'intensité lumineuse)
 - Réduire/éviter l'éclairage continu (utiliser la fonction de déclenchement)
 - Éteindre l'éclairage lorsqu'il n'est pas utilisé pendant de longues périodes

-  Dissiper la chaleur d'émission comme suit:

 - Installer sur une surface froide (structure de la machine)
 - Installer sur un élément refroidissant externe

-  Nettoyer régulièrement

L'encrassement entrave la bonne émission de l'éclairage et accroît l'émission de chaleur.