

BE-R30-G0-K-BS-DIF

Ringbeleuchtung
Ringlight
Anneau lumineux

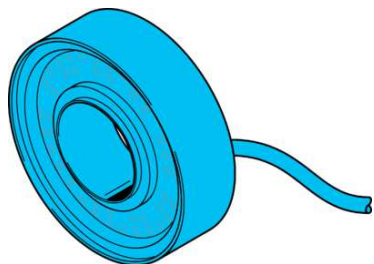

di-soric GmbH & Co. KG
Steinbeisstraße 6
DE-73660 Urbach
Germany
Tel: +49 (0) 7181/9879-0
info@di-soric.com · www.di-soric.com

209558

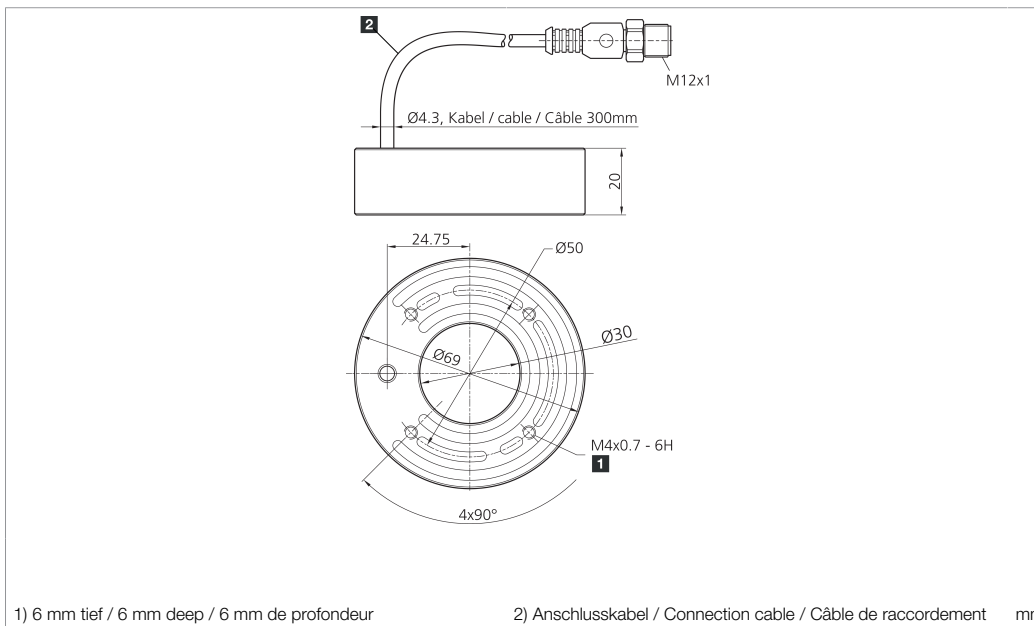

1) 6 mm tief / 6 mm deep / 6 mm de profondeur

2) Anschlusskabel / Connection cable / Câble de raccordement mm

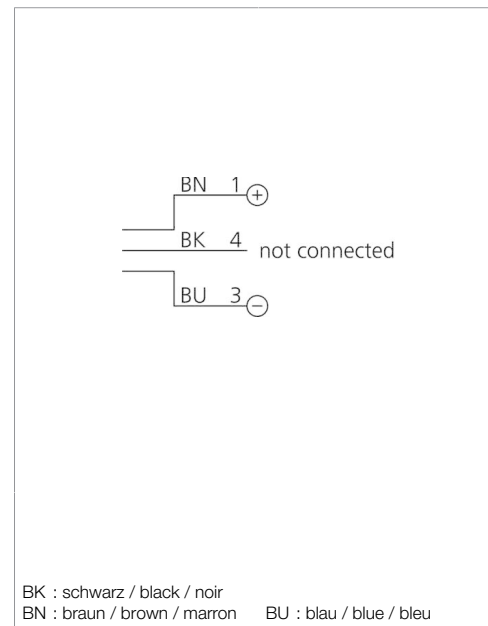

BK : schwarz / black / noir

BN : braun / brown / marron

BU : blau / blue / bleu

Technische Daten	Technical data	Caractéristiques techniques	+20°C, 24 V DC
Besonderheiten	Characteristics	Particularités	Modernste High-Power-LEDs / State-of-the-art high power LEDs / LED haute puissance ultra-modernes
Lichtfarbe	Light color	Couleur de lumière	Infrarot / Infrared / Infrarouge
Abstrahlwinkel FWHM	Deflection angle FWHM	Angle d'émission FWHM	90°
Betriebsspannung	Service voltage	Tension de service	24 V DC (Supply Class 2)
Leistung	Power	Puissance	4,8 W / 24 V DC / 4,8 W / 24 V DC / 4,8 W / 24 V DC
Umgebungstemperatur Betrieb	Ambient temperature during operation	Température ambiante de fonctionnement	0 ... +40 °C
Schutzart	Protection type	Indice de protection	IP 67
Risikogruppe (DIN EN 62471)	Risk group (DIN EN 62471)	Groupe de risque (DIN EN 62471)	Freie Gruppe / Free group / Groupe libre

Stand 22.10.24, Änderungen vorbehalten

As of 10/22/24, subject to change

État 22.10.24, sous réserve de modifications

Supply Class 2 Enclosure Type 1 NFPA 79 Applications only. For adapters providing field wiring means refer to product information or customer support.

IND. CONT. EQ. 29W7

Sicherheitshinweise

Allgemeiner Sicherheitshinweis
WARNUNG! Kein Sicherheitsbauteil gemäß 2006/42/EG und EN 61496-1/-2! Darf nicht zum Personenschutz eingesetzt werden! Nichtbeachtung kann zu Tod oder schwersten Verletzungen führen! Nur bestimmungsgemäß verwenden!

Safety instructions

General safety notice
WARNING! Not a safety component pursuant to 2006/42/EG and EN 61496-1/-2! May not be used for personal protection! Non-compliance can lead to death or serious injuries! Only use as directed!

Consignes de sécurité

Consigne de sécurité générale
AVERTISSEMENT ! Ce produit n'est pas un composant de sécurité au sens des réglementations 2006/42/CE et NF EN 61496-1/-2 ! Ne pas l'utiliser pour la protection des personnes ! Le non-respect de cette consigne peut entraîner la mort ou des blessures graves ! N'utiliser le produit que selon son utilisation conforme !

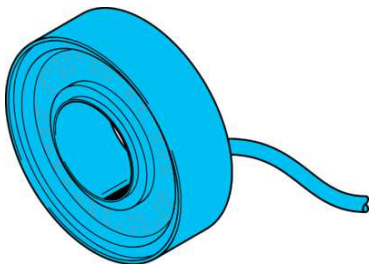





di-soric GmbH & Co. KG
 Steinbeisstraße 6
 DE-73660 Urbach
 Germany
 Tel: +49 (0) 7181/9879-0
 info@di-soric.com · www.di-soric.com

209558



版本 24.10.22, 保留变更权

 Supply Class 2 Enclosure Type 1
 NFPA 79 Applications only. For ad-
 apters providing field wiring me-
 ans refer to product information or
 customer support.
 IND. CONT. EQ.
 29W7



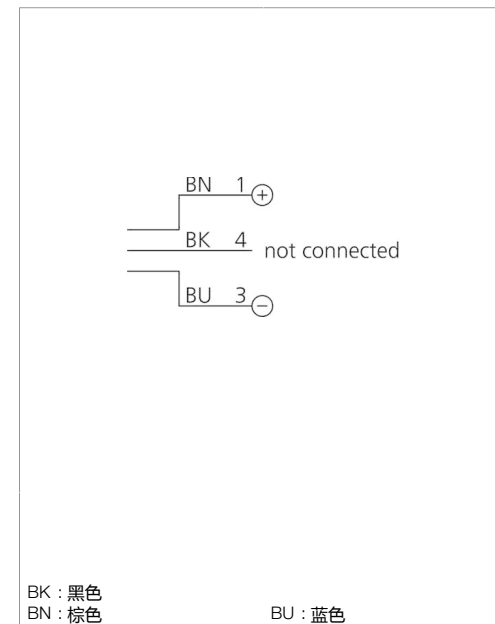
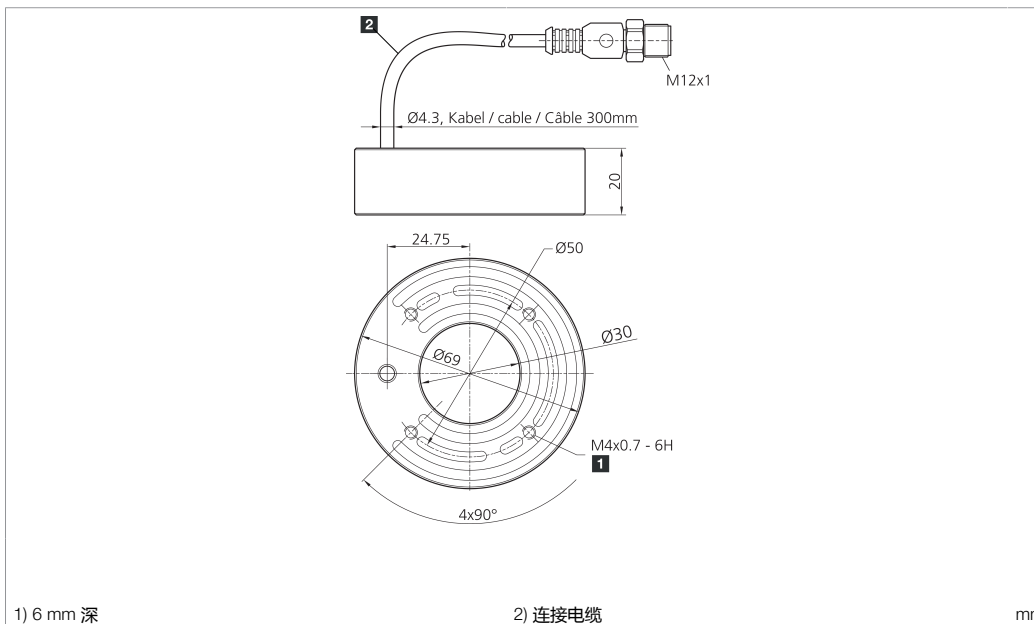



技术数据	+20°C, 24 V DC
特点	最先进的 High-Power-LED
光色	红外
发射角 FWHM	90°
工作电压	24 V DC (Supply Class 2)
功率	4.8 W / 24 V DC
工作环境温度	0 ... +40 °C
防护等级	IP 67
风险组 (DIN EN 62471)	无危险类

安全提示

一般安全提示

 警告！没有符合 2006/42/EU 和 EN 61496-1 /-2 标准的安全结构件！不得用于人身安全保护！不遵守规定会导致死亡或重伤危险！仅按规定使用！

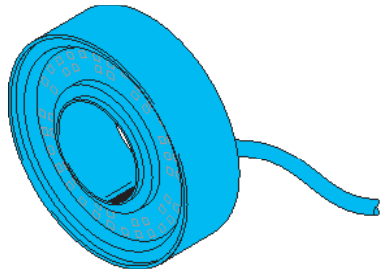



Ringbeleuchtung

- 
 Nicht dauerhaft in den Lichtstrahl blicken!

- 
 Diese Beleuchtung erzeugt eine sichtbare oder unsichtbare Strahlung, welche bei dauerhafter Einwirkung schädlich sein kann!

- 
 Wärmekonvektion gewährleisten!
 Die Erwärmung der Beleuchtung hat einen direkten Einfluss auf die Alterung/Lebensdauer der Beleuchtungs-LEDs! Je höher die Temperatur, desto stärker die Alterung.

- 
 - Beleuchtung nicht abdecken
 - Beleuchtungsintensität an die Applikation anpassen (überschüssige Lichtstärke vermeiden)
 - Dauerlicht reduzieren/vermeiden (Triggerfunktion nutzen)
 - Beleuchtung bei längerer Nichtnutzung abschalten

- 
 Betriebswärme folgendermaßen abführen:
 - Montage an eine kühlende Fläche (Maschinenkörper)
 - Montage an einen externen Kühlkörper

- 
 Regelmäßige Reinigung!
 Starke Verschmutzung verhindert den Lichtaustritt und erhöht die Wärmeentwicklung.

Ringlight

- 
 Do not look into the light beam for a prolonged period of time!

- 
 This light produces radiation which may or may not be visible and prolonged exposure may be harmful!

- 
 Ensure heat convection!
 The heating of the light has a direct impact on the ageing/lifetime of the light LEDs! The higher the temperature, the faster the ageing process.

- 
 - Do not cover the light
 - Adapt the light intensity to the application (avoid excessive light intensity)
 - Reduce/avoid continuous light (use trigger function)
 - Switch off light when it is not being used for longer periods of time

- 
 Dissipate operating heat as follows:
 - Install on a cool surface (machine structure)
 - Install on an external cooling element

- 
 Clean on a regular basis!
 Heavy contamination prevents light emission and increases heat development.

Anneau lumineux

- 
 Ne pas regarder le rayon lumineux pendant une période de temps prolongée!

- 
 Cette lumière produit des radiations qui pourraient ou ne pourraient pas être visibles et une exposition prolongée peut être nuisible!

- 
 Protéger de l'émission de chaleur!
 La chaleur émise par la lumière a un effet direct sur le vieillissement/la durée de vie des LED! Plus la température s'élève, plus rapide est le processus de vieillissement.

- 
 - Ne pas couvrir la lumière
 - Adapter l'intensité lumineuse en fonction de la nécessité de l'application (éviter l'excès d'intensité lumineuse)
 - Réduire/éviter l'éclairage continu (utiliser la fonction de déclenchement)
 - Éteindre l'éclairage lorsqu'il n'est pas utilisé pendant de longues périodes

- 
 Dissiper la chaleur d'émission comme suit:
 - Installer sur une surface froide (structure de la machine)
 - Installer sur un élément refroidissant externe

- 
 Nettoyer régulièrement
 L'encrassement entrave la bonne émission de l'éclairage et accroît l'émission de chaleur.