

BEK-A100-G2T-K-BS

Aufsichtbeleuchtung
Barlight
Barre d'éclairage

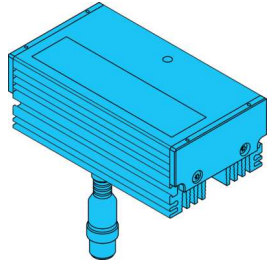

di-soric GmbH & Co. KG
Steinbeisstraße 6
DE-73660 Urbach
Germany
Tel: +49 (0) 7181/9879-0
info@di-soric.com · www.di-soric.com

208175

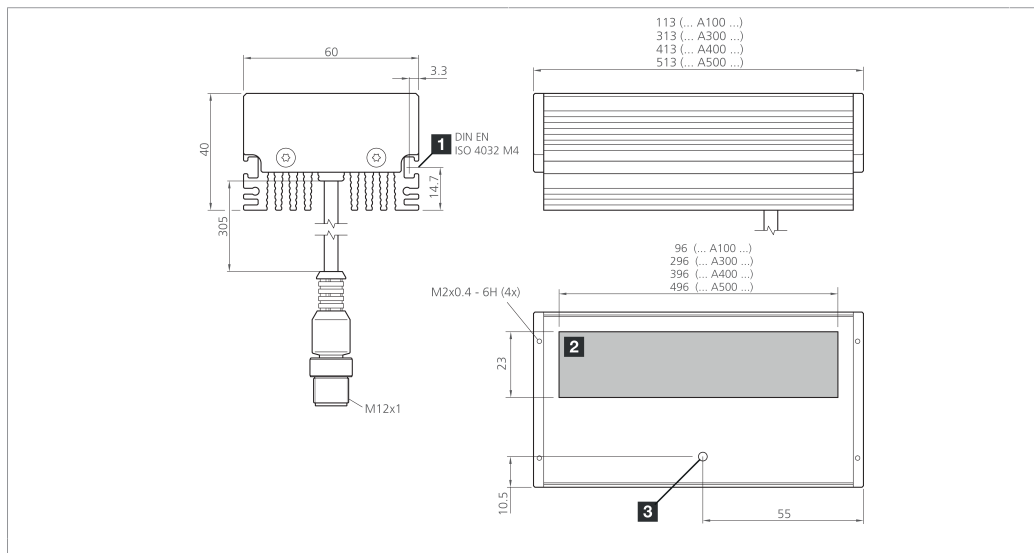

- 1) Befestigungsnut für Mutter / Mounting groove for nut / Rainure de fixation pour écrou
2) Leuchtfläche / Illuminated area / Surface d'éclairage
3) LED BETRIEB / LED OPERATION / LED FONCTIONNEMENT mm

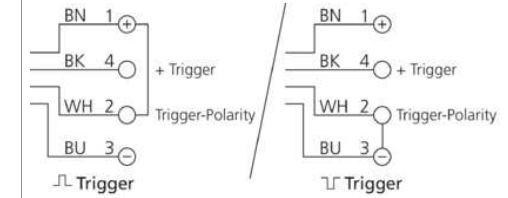





BK : schwarz / black / noir BU : blau / blue / bleu
BN : braun / brown / marron WH : weiß / white / blanc



Technische Daten	Technical data	Caractéristiques techniques	+20°C, 24 V DC
Betriebsspannung	Service voltage	Tension de service	18 ... 30 V DC (Supply Class 2)
Eigenstromaufnahme	Internal power consumption	Consommation de courant	550 mA (24 V DC)
Leistung	Power	Puissance	13 W / 24 V DC
Umgebungstemperatur Betrieb	Ambient temperature during operation	Température ambiante de fonctionnement	0 ... +40 °C
Schutzart	Protection type	Indice de protection	IP 67
Risikogruppe (DIN EN 62471)	Risk group (DIN EN 62471)	Groupe de risque (DIN EN 62471)	Freie Gruppe / Free group / Groupe libre
Schutzklasse	Protection class	Classe de protection	III, Betrieb an Schutzkleinspannung / III, operation on protective low voltage / III, utilisation en très basse tension de sécurité

Stand 22.10.24, Änderungen vorbehalten

As of 10/22/24, subject to change

État 22.10.24, sous réserve de modifications

 Supply Class 2 Enclosure Type 1
 NFPA 79 Applications only. For ad-
 apters providing field wiring me-
 ans refer to product information or
 customer support.
 IND. CONT. EQ.
 29W7



Sicherheitshinweise	Safety instructions	Consignes de sécurité
 Allgemeiner Sicherheitshinweis WARNUNG! Kein Sicherheitsbauteil gemäß 2006/42/EG und EN 61496-1 /-2! Darf nicht zum Personenschutz eingesetzt werden! Nichtbeachtung kann zu Tod oder schwersten Verletzungen führen! Nur bestimmungsgemäß verwenden!	 General safety notice WARNING! Not a safety component pursuant to 2006/42/EG and EN 61496-1/-2! May not be used for personal protection! Non-compliance can lead to death or serious injuries! Only use as directed!	 Consigne de sécurité générale AVERTISSEMENT ! Ce produit n'est pas un composant de sécurité au sens des réglementations 2006/42/CE et NF EN 61496-1/-2 ! Ne pas l'utiliser pour la protection des personnes ! Le non-respect de cette consigne peut entraîner la mort ou des blessures graves ! N'utiliser le produit que selon son utilisation conforme !

BEK-A100-G2T-K-BS

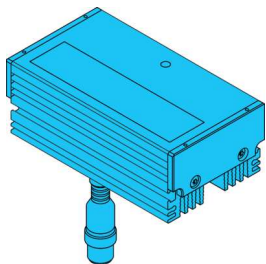
条形光源



di-soric GmbH & Co. KG
 Steinbeisstraße 6
 DE-73660 Urbach
 Germany
 Tel: +49 (0) 7181/9879-0
 info@di-soric.com · www.di-soric.com

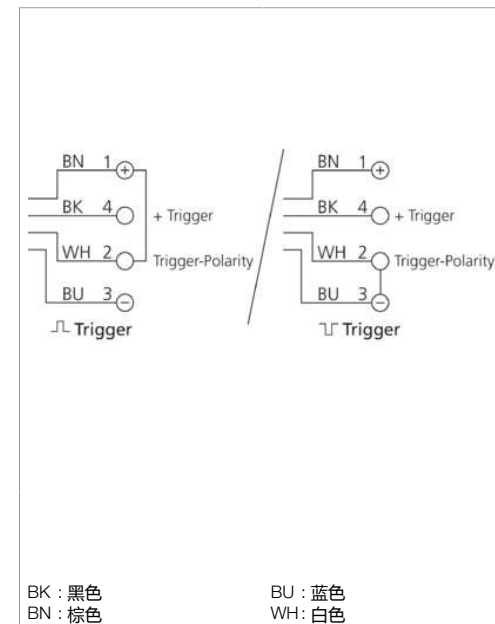
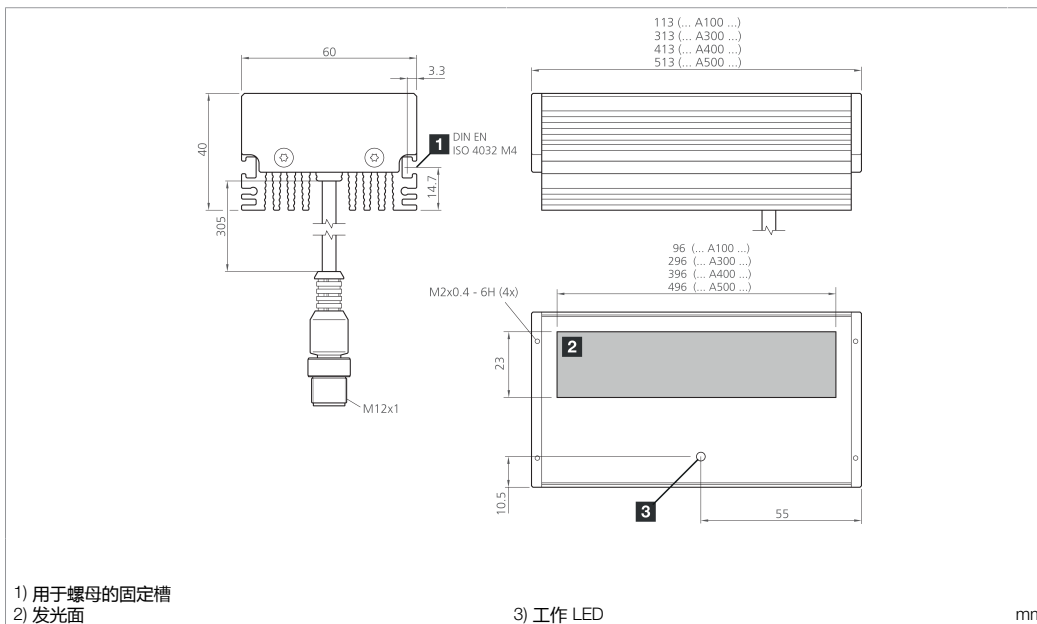

208175



技术数据	+20°C, 24 V DC
工作电压	18 ... 30 V DC (Supply Class 2)
内部功耗	550 mA (24 V DC)
功率	13 W / 24 V DC
工作环境温度	0 ... +40 °C
防护等级	IP 67
风险组 (DIN EN 62471)	无危险类
防护等级	III, 在安全特低电压下工作

版本 24.10.22, 保留变更权

 Supply Class 2 Enclosure Type 1
 NFPA 79 Applications only. For ad-
 apters providing field wiring me-
 ans refer to product information or
 customer support.
 IND. CONT. EQ.
 29W7

安全提示

一般安全提示
 警告！没有符合 2006/42/EU 和 EN 61496-1 /-2 标准的安全结构件！不得用于人身安全保护！不遵守规定会导致死亡或重伤危险！仅按规定使用！

Flächenbeleuchtung

Aufgrund des technisch bedingt erhöhten Einschaltstroms empfehlen wir eine geeignete Stromversorgung, die kurzzeitig mindestens 5A liefern kann.



Nicht dauerhaft in den Lichtstrahl blicken!



Diese Beleuchtung erzeugt eine sichtbare oder unsichtbare Strahlung, welche bei dauerhafter Einwirkung schädlich sein kann!



Wärme Konvektion gewährleisten!

Die Erwärmung der Beleuchtung hat einen direkten Einfluss auf die Alterung/Lebensdauer der Beleuchtungs-LEDs! Je höher die Temperatur, desto stärker die Alterung.



- Beleuchtung nicht abdecken

- Beleuchtungsintensität an die Applikation anpassen (überschüssige Lichtstärke vermeiden)

- Dauerlicht reduzieren/vermeiden (Triggerfunktion nutzen)

- Beleuchtung bei längerer Nichtnutzung abschalten



Betriebswärme folgendermaßen abführen:

- Montage an eine kühlende Fläche (Maschinenkörper)

- Montage an einen externen Kühlkörper



Regelmäßige Reinigung!

Starke Verschmutzung verhindert den Lichtaustritt und erhöht die Wärmeentwicklung.

Back light

Due to technical reasons increased inrush current we recommend a suitable power supply delivering a short-term capacity of 5A.



Do not look into the light beam for a prolonged period of time!



This light produces radiation which may or may not be visible and prolonged exposure may be harmful!



Ensure heat convection!

The heating of the light has a direct impact on the ageing/lifetime of the light LEDs! The higher the temperature, the faster the ageing process.



- Do not cover the light

- Adapt the light intensity to the application (avoid excessive light intensity)

- Reduce/avoid continuous light (use trigger function)

- Switch off light when it is not being used for longer periods of time



Dissipate operating heat as follows:

- Install on a cool surface (machine structure)

- Install on an external cooling element



Clean on a regular basis!

Heavy contamination prevents light emission and increases heat development.

Rétro-éclairage

Pour des raisons techniques dû au courant d'appel, nous recommandons l'utilisation d'une alimentation de 5A.



Ne pas regarder le rayon lumineux pendant une période de temps prolongée!



Cette lumière produit des radiations qui pourraient ou ne pourraient pas être visibles et une exposition prolongée peut être nuisible!



Protéger de l'émission de chaleur!

La chaleur émise par la lumière a un effet direct sur le vieillissement/la durée de vie des LED! Plus la température s'élève, plus rapide est le processus de vieillissement.s



- Ne pas couvrir la lumière

- Adapter l'intensité lumineuse en fonction de la nécessité de l'application (éviter l'excès d'intensité lumineuse)

- Réduire/éviter l'éclairage continu (utiliser la fonction de déclenchement)

- Éteindre l'éclairage lorsqu'il n'est pas utilisé pendant de longues périodes



Dissiper la chaleur d'émission comme suit:

- Installer sur une surface froide (structure de la machine)

- Installer sur un élément refroidissant externe



Nettoyer régulièrement

L'encrassement entrave la bonne émission de l'éclairage et accroît l'émission de chaleur.

